

## **bathfan Series**

A comprehensive bathroom ventilation solution



## Introducing bathfan

Revolutionize your bathroom experience with our remarkable new product line! Designed to enhance ventilation and elevate comfort, bathfan offers a diverse range of bathroom fans to suit every need. With five distinct categories, ranging from sleek and simple designs to those packed with advanced features, we guarantee a perfect match for your space. Say goodbye to stale air and hello to optimal freshness! Experience the power of bathfan and transform your bathroom into a haven of tranquility. Upgrade your ventilation game today!

## Naming structure

The naming structure may look like a series of numbers and letters, but it's packed with information. It may seem complex, but once you understand it, you'll have all the information you need to determine the features of the fans. Let's break it down:

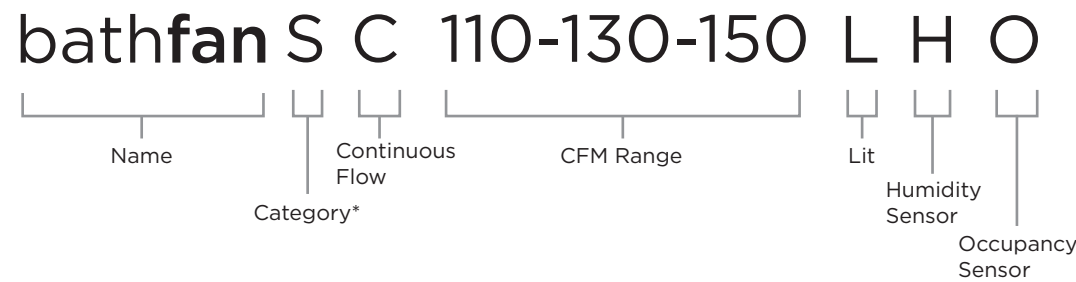

\*S=Select, SF=Select Fit, SMPL=Simple, RCS=Recessed, COM=Commercial



Featured fan: bathfan SMPL80

## Product line



### SIMPLE R

Our most basic fan that will get the job done. These simple bath fans are great for bathrooms that range from 80 to 100 sq. ft.



### SELECT FIT R

These fans feature a low profile design and are ideal for bathrooms less than 100 sq. ft. thanks to their constant volume capabilities. Occupancy and humidity sensors are optional features.



### SELECT R

Self-compensating DC motor makes it great for bathrooms less than 150 sq. ft. Occupancy and humidity sensors are great options for this Series.\*  
\*Applies to 110-130-150 cfm fans



### RECESSED R

Sleek and modern design that doesn't take up a lot of space. Perfect for bathrooms less than 80 sq. ft.



### COMMERCIAL R

Great for commercial bathrooms that are up to 500 sq. ft. The constant volume holds rated airflow over large static pressure range.

## SIMPLE SERIES

Say goodbye to the woes of stuffy, humid bathrooms with the bathfan SIMPLE - the epitome of simplicity and effectiveness in bathroom ventilation. Designed to cater to smaller spaces, this unassuming yet powerful fan is the perfect addition for bathrooms spanning **up to 80 or up to 100 square feet**.

With a **single-speed** operation, bathfan SIMPLE takes the guesswork out of choosing the right setting. You won't need to fuss with complicated settings or adjustments. With just a flip of the switch, the fan springs to life, providing continuous and reliable ventilation. This simplicity is not only convenient but also ensures that the fan operates at its optimal performance level, effectively removing moisture and unpleasant odors from your bathroom.

The **2x4 installation** design makes it incredibly easy to set up. This specific sizing means it's perfectly compatible with standard 2x4 ceiling joists, making the installation process hassle-free for homeowners and contractors alike. This streamlined installation not only saves time but also ensures a secure and snug fit, minimizing any potential gaps or leaks in your bathroom's ceiling.

You have the option to choose between a **lit or unlit** configuration, allowing you to customize your

bathroom's ambiance to suit your preferences. If you want to keep the fan low-profile and inconspicuous, you can opt for the unlit version. On the other hand, if you'd like to enhance your bathroom's lighting while maintaining efficient ventilation, you can select the lit option. This lighting choice ensures that your bathroom not only remains fresh and comfortable but also well-illuminated.

At the heart of this unobtrusive bathroom fan are reliable **AC motors**, ensuring longevity and efficiency. It effortlessly removes excess moisture, odors, and impurities, creating a comfortable and fresh environment for you to enjoy.

Experience simplicity and functionality at its finest with the bathfan SIMPLE. Your bathroom's comfort is just a switch away!





Featured fan: bathfan SMPL80

## Product Features



- 

SINGLE SPEED
- 

80 OR 100 CFM
- 

UP TO 80 SQ. FT. BATHROOMS  
UP TO 100 SQ. FT. BATHROOMS
- 

AC MOTOR



## Product Offering

The bathfan Simple Series offers four models.



NO LIGHT

bathfan SMPL80  
bathfan SMPL100



LIGHT

bathfan SMPL80L  
bathfan SMPL100L

## SELECT FIT SERIES

The bathfan SELECT FIT is a **highly versatile and efficient bathroom fan** designed to fit in **2x4 construction**, provides superior ventilation and comfort in residential settings. With its comprehensive features and customizable options, it offers an optimal solution for maintaining a clean, fresh, and comfortable bathroom environment.

One of the standout features of the bathfan SELECT FIT is its speed selectability. Users have the flexibility to choose from multiple fan speeds, allowing them to adjust the ventilation flow according to their specific needs. Whether you require a gentle airflow or more robust ventilation, this fan can cater to your preferences with ease. The speed selection makes buying fans easier for you build, buy bathfan SELECT FIT for all the bathrooms and adjust the flow as necessary.

The bathfan SELECT FIT grilles come with or without a light. The lighted option eliminates the need for separate lighting installations, providing a space-saving and convenient solution and has an option for a night light.

For enhanced convenience and energy efficiency, the bathfan SELECT FIT also offers **optional occupancy and humidity sensors**. The occupancy sensor detects motion within the bathroom, activating the fan automatically when someone enters the space.

Ensuring that ventilation is only operating when needed, optimizing energy consumption and comfort. The humidity sensor detects changes in humidity levels, automatically adjusting the fan speed to effectively remove excess moisture from the air, preventing mold and mildew growth.

Furthermore, the bathfan SELECT FIT provides **continuous flow** options. The fan can operate continuously, even when the bathroom is unoccupied. This feature helps to maintain consistent air circulation, preventing stale air and unpleasant odors from lingering in the room.







Overall, the bathfan SELECT FIT is a high-performance bathroom fan that combines speed selectability, optional occupancy and humidity sensors, continuous flow options and strong static pressure performance. Its versatility and advanced features ensures optimal ventilation, comfort, and energy efficiency, making it an excellent choice for any bathroom.

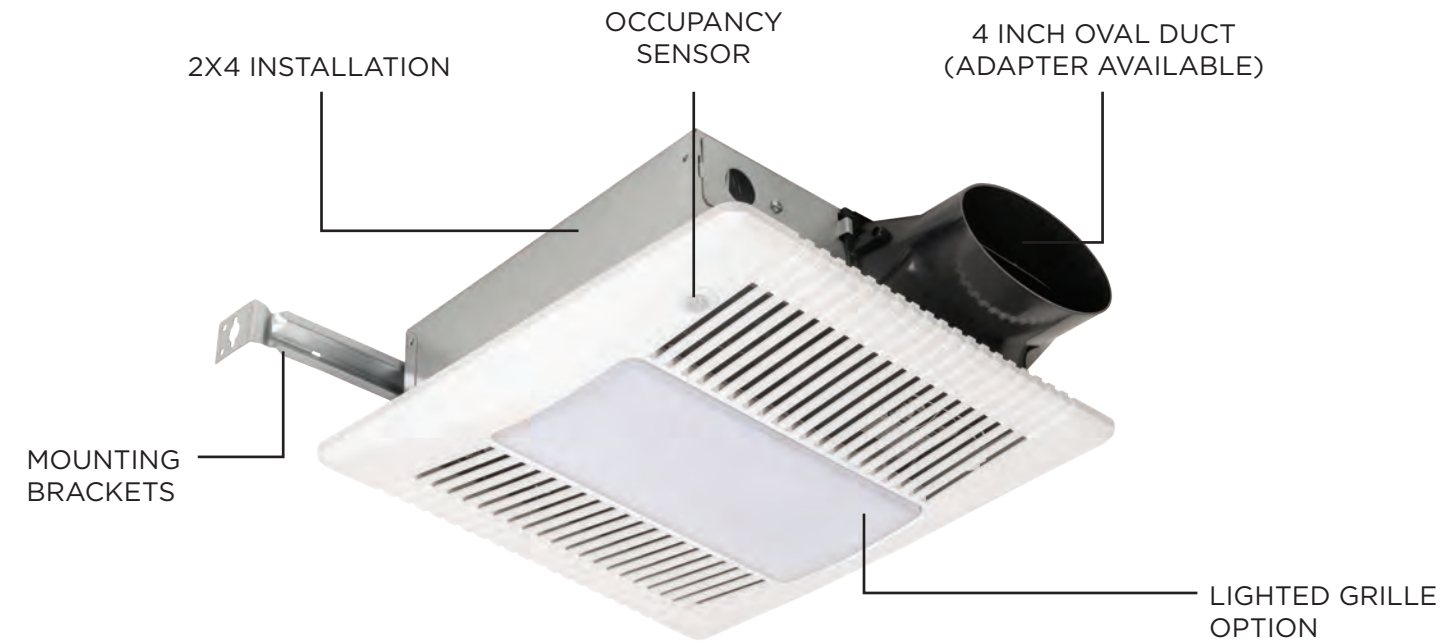

Featured fan: bathfan SFC50-80-100LHO

## Product Features



-  SPEED SELECTABLE
-  50-80-100 CFM
-  <100 SQ. FT. BATHROOMS
-  CONTINUOUS FLOW (ASHRAE 62.2 COMPLIANT OPTIONS)
-  OCCUPANCY SENSOR (OPTIONAL)
-  DC MOTOR
-  HUMIDITY SENSOR (OPTIONAL)



ALL MODELS

**ASHRAE 62.2**

SOME MODELS

## Product Offering

The bathfan Select Fit Series offers eight models.



NO LIGHT  
**bathfan SF50-80-100**  
**bathfan SFC50-80-100**  
**bathfan SFC50-80-100H**



LIGHT  
**bathfan SF50-80-100L**  
**bathfan SFC50-80-100L**  
**bathfan SFC50-80-100LH**



NO LIGHT, HUMIDITY, OCCUPANCY  
**bathfan SFC50-80-100HO**



LIGHT, HUMIDITY, OCCUPANCY  
**bathfan SFC50-80-100LHO**

## SELECT SERIES

The bathfan SELECT, with its **larger size and higher cubic feet per minute (CFM) range, and quieter operation**, this fan ensures optimal air circulation and exhaust capability, providing you with a fresher and more comfortable bathroom environment.

One of the standout features of the bathfan SELECT is its versatility. Equipped with **optional occupancy and humidity sensors**, this fan automatically detects the presence of occupants and adjusts its operation accordingly. It intelligently detects changes in humidity levels, activating the fan when excess moisture is detected, effectively preventing mold and mildew growth. This smart functionality not only saves energy but also ensures that the fan operates precisely when needed.

Furthermore, the bathfan SELECT offers lighted or non lighted grille options to suit your specific preferences. The lighted option also has a great night light. This feature eliminates the need for separate lighting installations, providing a space-saving and convenient solution.

In addition to its sensor and light options, the bathfan SELECT also

offers **continuous flow** capabilities. This means that the fan can remain on continuously, providing constant air circulation and ventilation even when the bathroom is unoccupied. This feature is especially useful for eliminating stagnant air and maintaining a fresh atmosphere in your bathroom to meet regional specific code requirements.

Designed with convenience in mind, the bathfan SELECT is specifically engineered to fit within **2x8 construction or larger**, commonly found in residential homes.

Upgrade your bathroom ventilation with the bathfan SELECT and experience enhanced air quality, improved moisture control, and customizable options to create your ideal bathroom environment. Say goodbye to stuffiness and hello to a refreshing, comfortable space with the bathfan SELECT.



Featured fan: bathfan S110-130-150

## Product Features



SPEED SELECTABLE



50-80-110 CFM OR  
110-130-150 CFM



<110 OR <150 SQ. FT.  
BATHROOMS



CONTINUOUS FLOW  
(ASHRAE 62.2 COMPLIANT OPTIONS)



OCCUPANCY SENSOR  
(OPTIONAL)



DC MOTOR



HUMIDITY SENSOR  
(OPTIONAL)



ALL MODELS



ASHRAE  
62.2

SOME MODELS

## Product Offering

The bathfan Select Series offers eight models.



NO LIGHT

bathfan SC50-80-110

bathfan SC50-80-110H

bathfan S110-130-150

bathfan SC110-130-150H



LIGHT

bathfan SC50-80-110L

bathfan S110-130-150L

bathfan SC110-130-150LH



LIGHT, HUMIDITY, OCCUPANCY

bathfan SC110-130-150LHO



## RECESSED SERIES

The bathfan RECESSED combines functionality with a recessed light feature. Designed to efficiently ventilate your bathroom, it offers a single speed setting with a maximum airflow capacity of **80 CFM**.

This fan is specifically engineered to provide effective air circulation and eliminate excess moisture, odors, and humidity from your bathroom, promoting a comfortable and healthy environment. The 80 CFM rating ensures that it can adequately handle ventilation needs in smaller to medium-sized bathrooms.

In addition to its ventilation capabilities, the bathfan RECESSED also features a **recessed light**, making it a convenient and space-

saving choice. The recessed light is integrated seamlessly into the fan's design, providing both illumination and ventilation in a single fixture.

With its simple yet effective design, the bathfan RECESSED is an ideal choice for those seeking a reliable bathroom fan that fulfills the essential requirements of air circulation while incorporating a recessed light for added functionality.





Featured fan: bathfan RCS80L

## Product Features

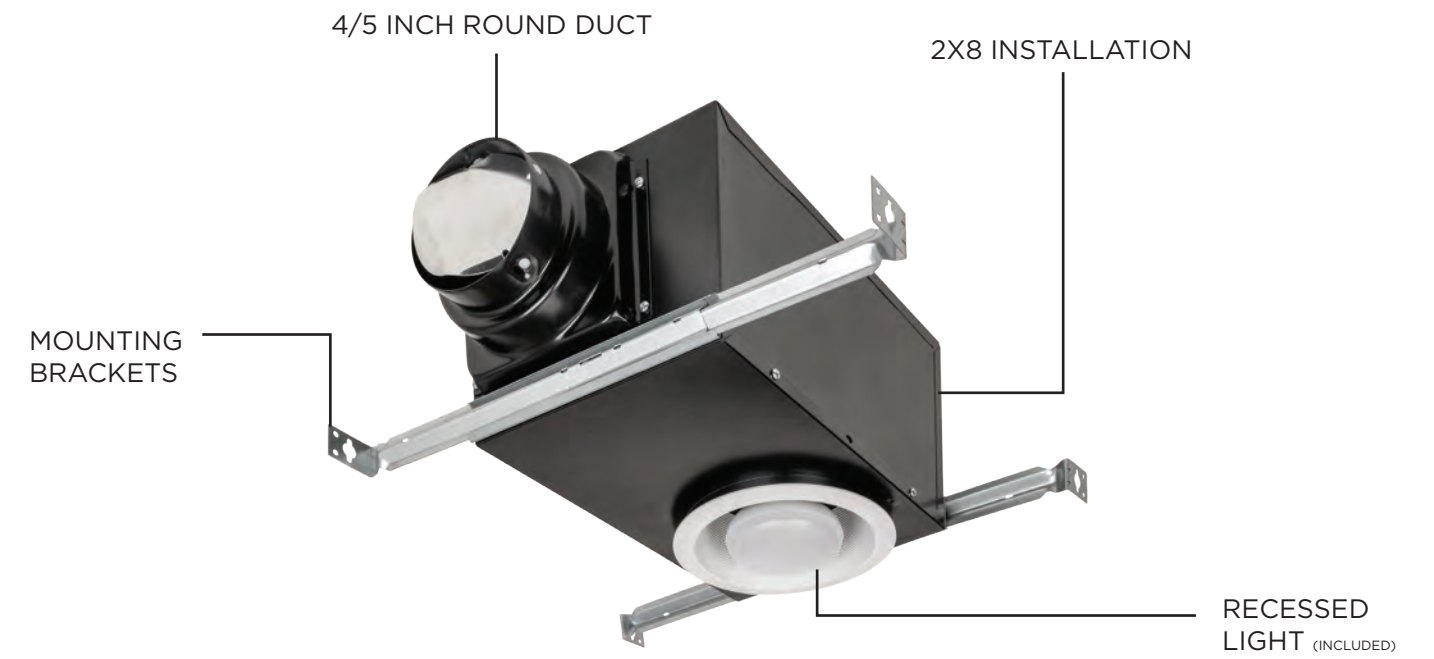

-  SINGLE SPEED
-  80 CFM
-  <80 SQ. FT. BATHROOMS
-  AC MOTOR



## Product Offering

The bathfan Recessed Series has one model.

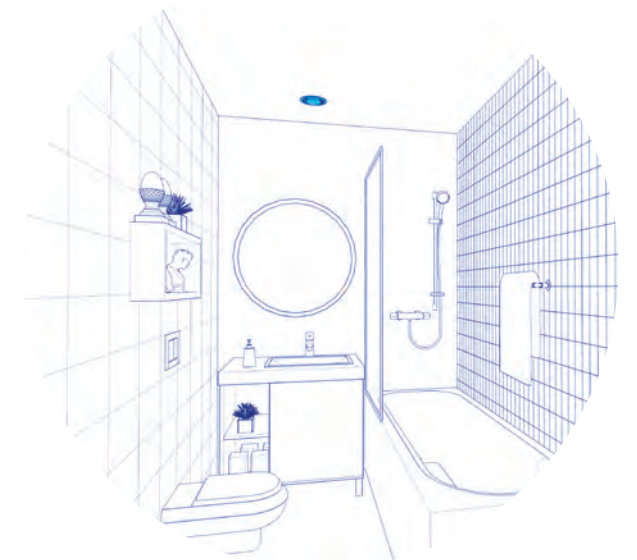

## COMMERCIAL SERIES

The bathfan COMMERCIAL is a specialized bathroom fan designed exclusively for **commercial settings**. Built to meet the ventilation needs of large-scale bathrooms, this fan prioritizes performance and reliability without any additional features.

With its robust design and powerful airflow capacity, the bathfan COMMERCIAL effectively removes moisture, odors, and humidity from commercial bathrooms, ensuring optimal air quality and comfort for patrons and employees. It is specifically engineered to meet the demanding requirements of high-traffic environments.

This commercial-grade fan **offers four speed options**, providing flexibility to adjust the ventilation according to the specific needs of the space. Whether it's a busy restroom or a spacious facility, it can accommodate various airflow requirements.

The streamlined design ensures seamless integration into any commercial bathroom setting. This fan is a practical choice for businesses and facilities that prioritize reliable and efficient ventilation without the need for additional features like lighting.

In summary, the bathfan COMMERCIAL is a powerful and dependable bathroom fan designed specifically for commercial environments. With its four-speed options and no-frills approach, it provides effective and customizable ventilation solutions for large-scale restrooms, making it an excellent choice for businesses that prioritize performance and reliability.





Featured fan: bathfan COM200-300-400-500

## Product Features



SPEED SELECTABLE



<500 SQ. FT. BATHROOMS



DC MOTOR



200-300-400-500 CFM



COMMERCIAL USE



## Product Offering

The bathfan Commercial Series has one model.



bathfan COM200-300-400-500

Whoa!  
**This is weird...**



**Flip me over for a  
second brochure!**

**Customer Support:**  
USA 800.747.1762 • USsupport@fantech.net  
CANADA 800.565.3548 • CANADAsupport@fantech.net

**Distributed Locally by:**

Systemair Inc. reserves the right to modify, at any time and without notice, any or all of its products' features, designs, components and specifications to maintain their technological leadership position. The application rendering presented in this brochure is for a visual presentation purpose only. Please, contact a professional for technical guidance.

Zephyr Creative • October 2024 • E1575



# Ventilation Solutions

## Premium Bathroom Fans



**fantech**<sup>®</sup>  
a systemair company





## PB Remote Bath Fan is the Right Choice

### Noise. Or lack thereof.

The icing on the cake with a remote fan installation is that the result is virtually **ZERO** sones.

### Small grille size.

PB Grilles are a fraction of the size compared to traditional ceiling fan models.

### 2 baths for the price of 1.

Dual grille Premium Bath fans can effectively ventilate two areas of the bathroom or two different bathrooms simultaneously.

## PB SERIES

Elevate your bathroom experience with the PB Series – a sophisticated solution that ensures a refreshing atmosphere in any space. In the world of bathroom ventilation, these fans are your quiet yet powerful allies. Discover the pinnacle of bathroom ventilation with the PB Series.

The subtle **single grille** fans are designed for smaller baths and powder rooms, efficiently combating humidity with their unobtrusive **7” ceiling grille** and whisper-quiet remote motor.

For larger bathrooms or complex layouts, choose the Fantech PB Series **dual grille** fans. They effectively ventilate **multiple areas**, strategically placed over showers, tubs, toilets, or vanities, all while maintaining super-quiet operation. Alternatively, install over two small-medium bathrooms. Upgrade your bathroom ventilation today with Fantech PB Series fans.

PB Series fans are designed to quietly and effectively **remove excess humidity** from your

bathroom, preventing mold, mildew, and moisture-related damage.

Enjoy **peace and tranquility** in your home with the fan motor located in a remote location, such as an attic, ensuring minimal noise disturbance while the fan works its magic.

PB fans are engineered to meet the stringent requirements of ASHRAE Standard 62.2, assuring you of their high performance and efficiency. Only when left on all the time or with proper controllers.

By eliminating excess humidity, these fans protect your home from the damaging effects of moisture, extending the life of fixtures and preserving your bathroom’s pristine condition.



Featured fan: PB110L10



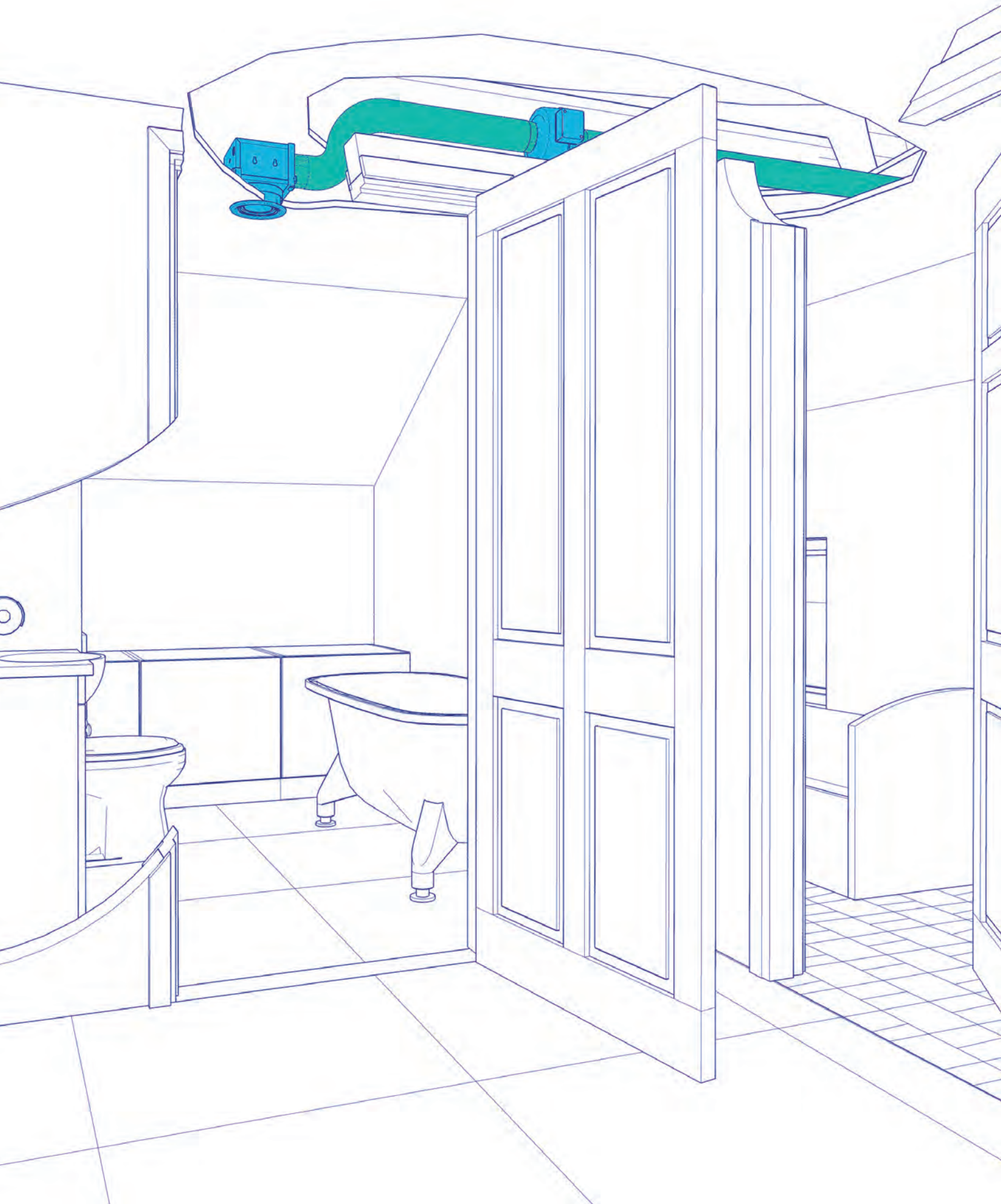

## PB Series - Single Grille Features

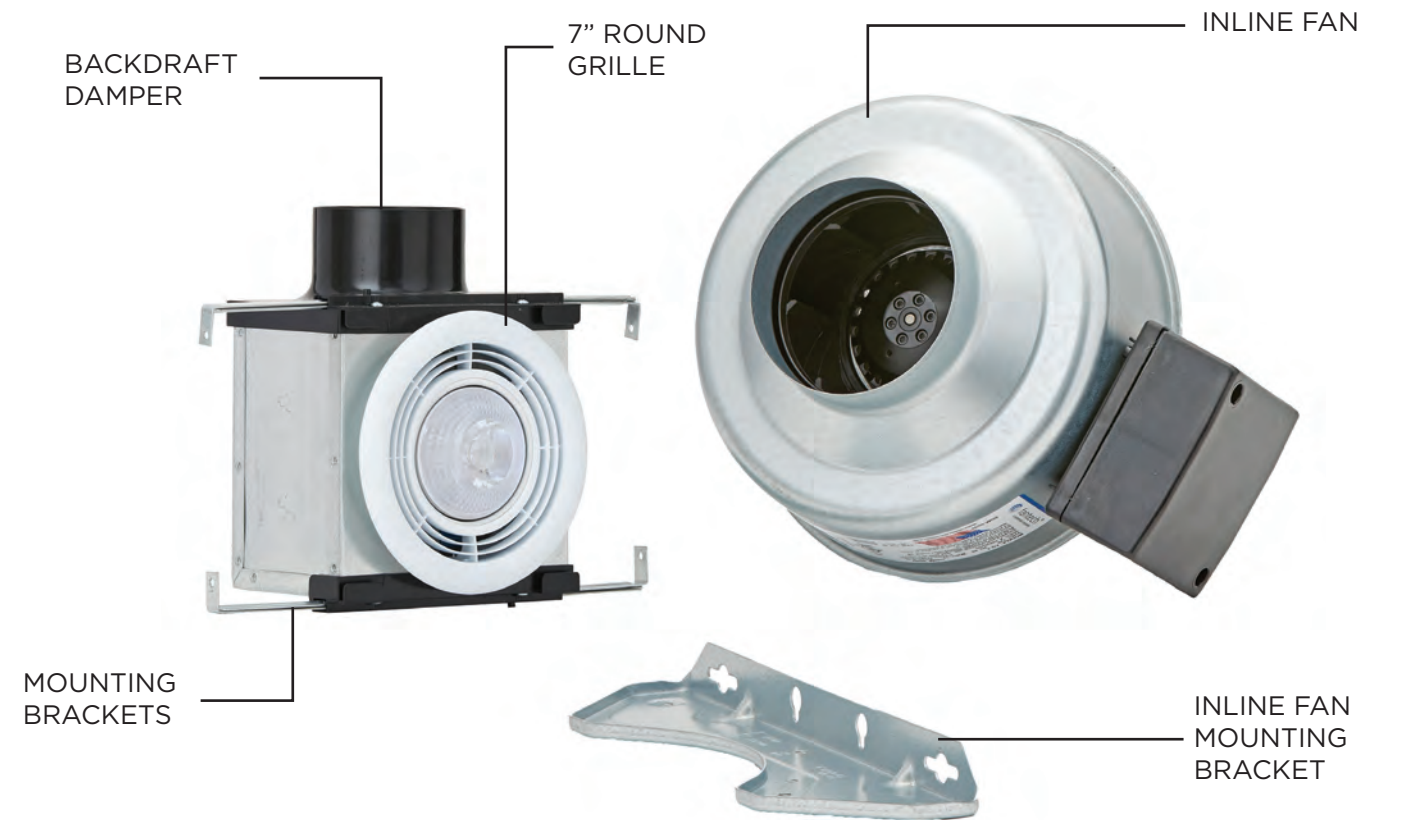

4\"/>



LIGHT OPTIONS



PB 110s: <100 SQ. FT. BATHROOMS  
PB 190: <200 SQ. FT. BATHROOMS



## Product Offering

The PB Series Single Grille Option has four models.



PB 110



PB 190



PB 110L10



PB 110L7

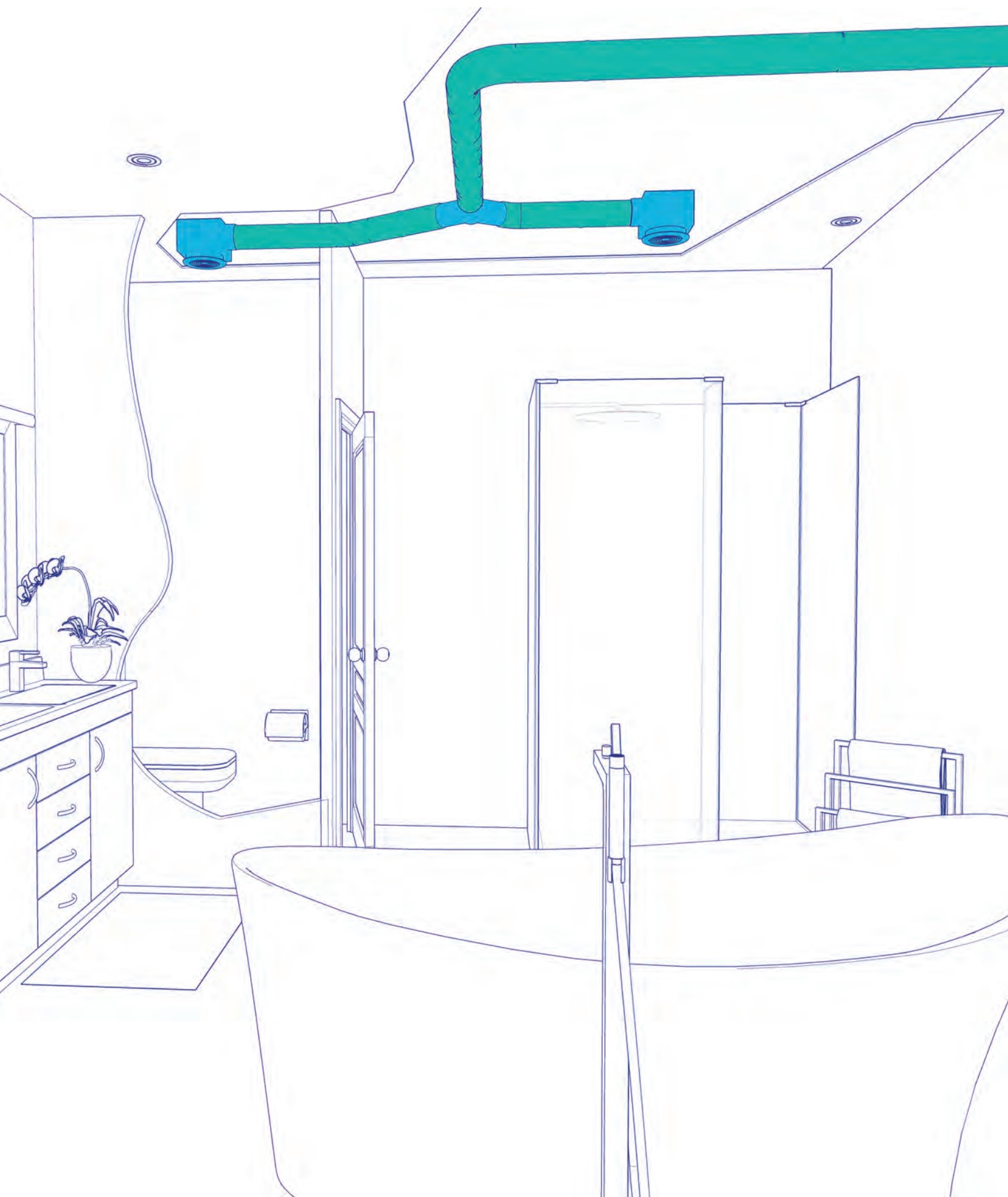

## PB Series - Dual Grille Features



4" DUCTING (GRILLES)  
6" DUCTING (FAN)

LIGHT OPTIONS

PB 270s: 200-250 SQ. FT. BATHROOMS  
PB 270-2s: 250-350 SQ. FT. BATHROOMS

TWO LOCATIONS



## Product Offering

The PB Series Dual Grille Option has seven models.



## This bathroom was brought to you by Fantech

Public bathrooms need fresh air so customers aren't distracted by smells other than their freshly ground coffee. In a configurable commercial environment you also need flexibility.

A Fantech remote bathroom fan allows a contractor to centrally mount a fan while taking care of multiple inlets at once. But what's more, if your client calls you back to move or add an additional bathroom, you can easily move the inlets without hassling with extra electrical or the purchase of additional expensive hardware.



### Why PB Fans?

Because of the compact nature of this commercial space, we can easily implement a PB 110 to meet our needs by installing a grille over each stall.



## PBW SERIES

The PBW Series is a game-changer in the world of silent ventilation and air quality control. Designed with precision and innovation in mind, this series sets a new standard for performance and efficiency.

This series delivers outstanding performance with powerful ventilation capabilities that ensure rapid air exchange, resulting in consistently fresh indoor air. Plus, it achieves this while being remarkably **energy-efficient**, helping you save on utility bills while maintaining superior performance.

One of the standout features of the PBW Series is its **quiet operation**. Whether you're using it in a residential or commercial setting, you'll appreciate the peace and tranquility it provides, making it an excellent choice for spaces where noise is a concern. **Installation is a breeze**, making it accessible to both professional installers and DIY enthusiasts.

Customization is at the heart of the PBW Series, allowing you to tailor the system to your unique

ventilation needs. This adaptability ensures the perfect solution for any space. Beyond its impressive performance, the PBW series brings a multitude of benefits. It actively improves indoor air quality by removing pollutants, allergens, and odors, creating a healthier environment.

In addition to all these advantages, you can trust in Fantech's reputation for reliability and durability, ensuring that your investment in the PBW Series will provide years of worry-free performance. In essence, Fantech's PBW series redefines indoor air management, offering unparalleled performance, efficiency, and peace of mind for your ventilation and air quality control needs.

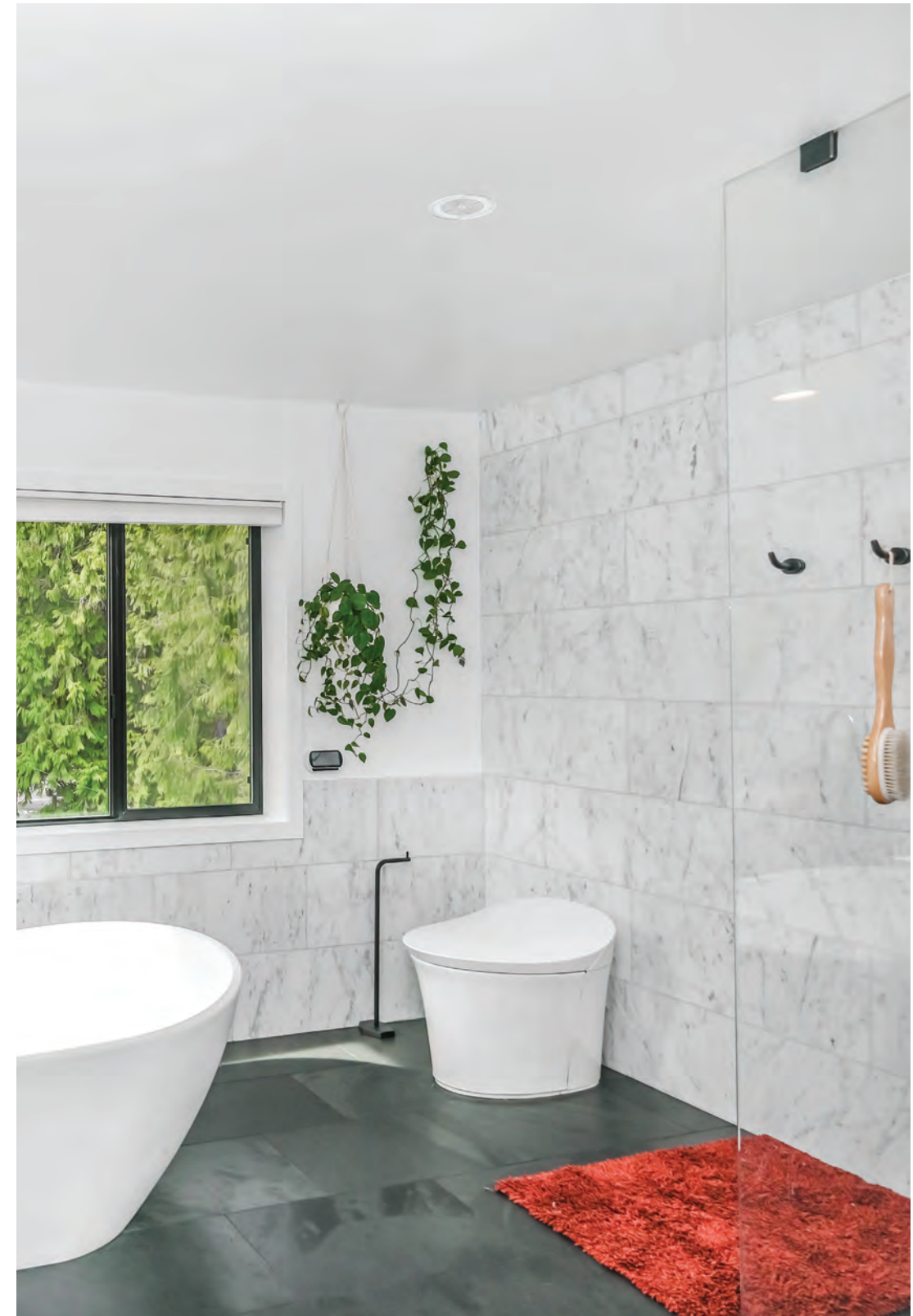

Featured solution: PBW 110

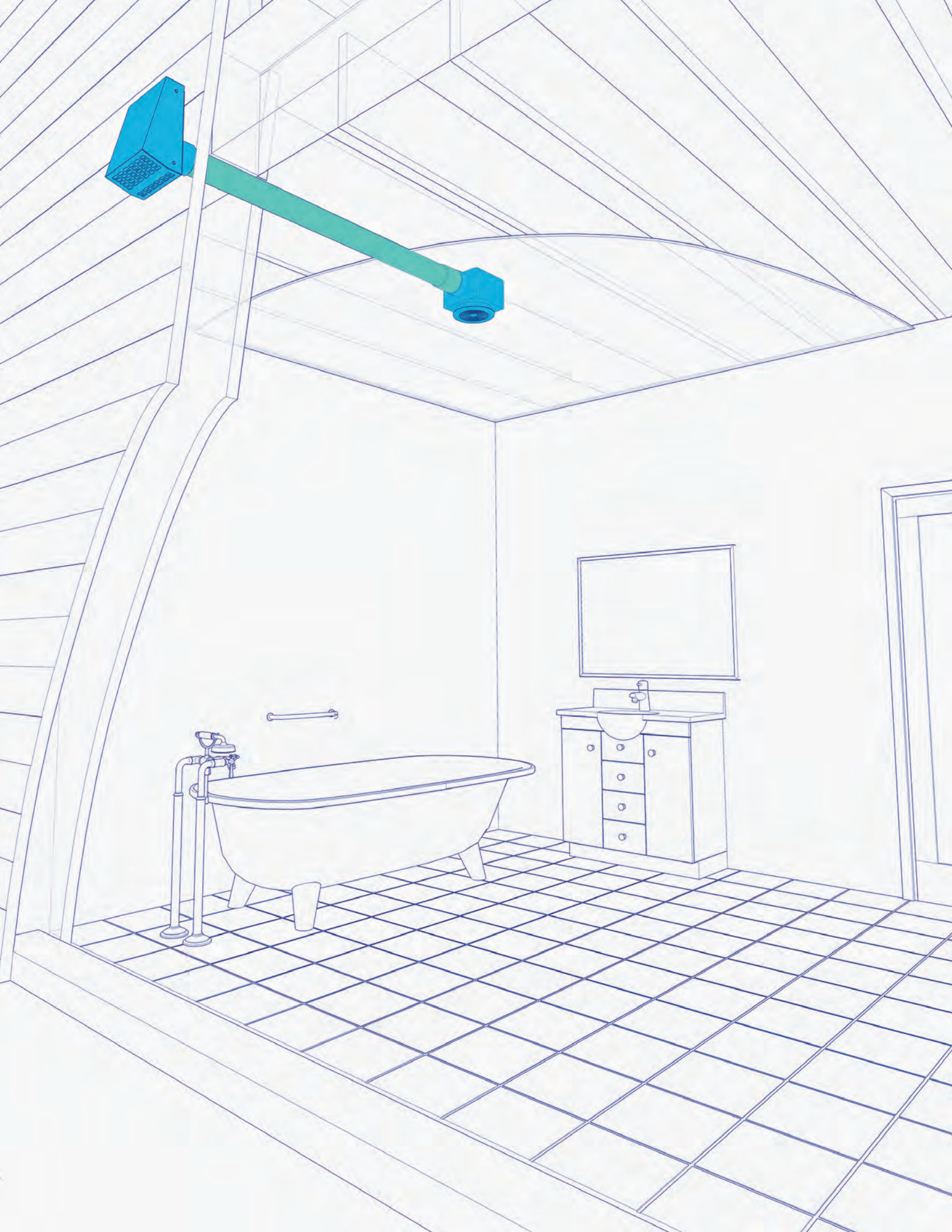

## Product Features

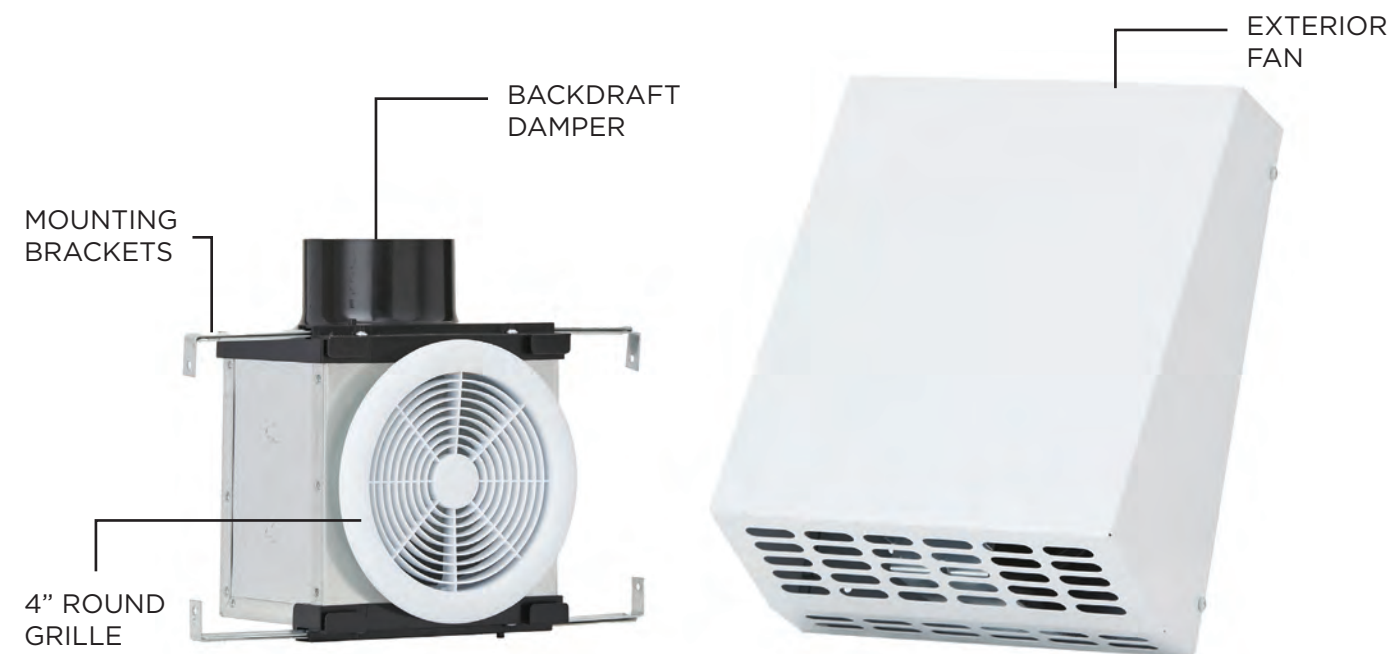

4" DUCTING



LIGHT OPTIONS



80-100 SQ. FT. BATHROOMS



ALL MODELS



ALL MODELS



SOME MODELS

## Product Offering

The PBW Series has three models.



PBW 110



PBW 110L10



PBW 110L7